

WAAS CH 78229 W31A	APP CRS 314°	Rwy Idg TDZE Apt Elev	3300 859 859
--	------------------------	-----------------------------	---

RNAV (GPS) RWY 31

WAUTOMA MUNI (Y50)

RNP APCH - GPS.

⚠ Circling Rwy 8, 26 NA. Rwy 13 helicopter visibility reduction below 1 SM NA. When local altimeter setting not received, use Oshkosh altimeter and increase all MDA 100 feet. Procedure NA at night.

MISSED APPROACH:
Climb to 3300 direct LOYIT and hold.

AWOS-3PT 119.475	MILWAUKEE APP CON 127.0 263.075	UNICOM 122.8 (CTAF) 0
----------------------------	---	---------------------------------

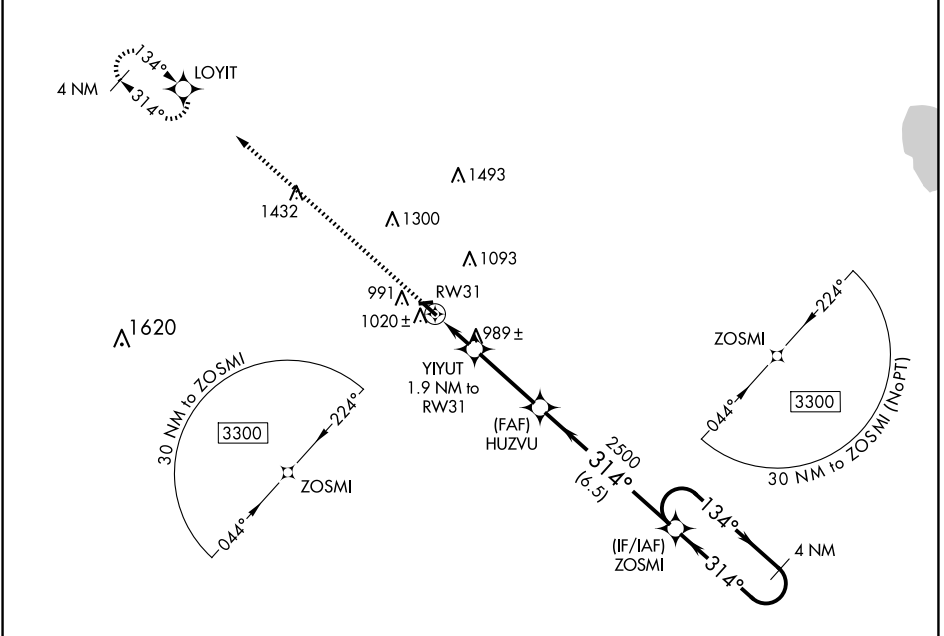

EC-3, 11 JUN 2026 to 09 JUL 2026

EC-3, 11 JUN 2026 to 09 JUL 2026

ELEV 859	TDZE 859
----------	----------

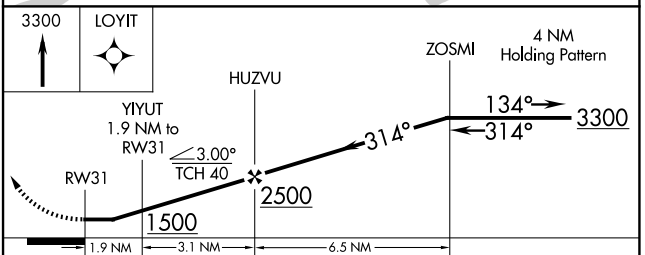
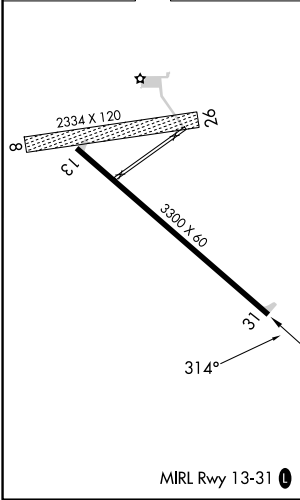

CATEGORY	A	B	C	D
LP MDA	1240-1	381 (400-1)		NA
LNAV MDA	1280-1	421 (500-1)		NA
CIRCLING	1340-1 481 (500-1)	1380-1 521 (600-1)		NA